

Specification for production parts (for production and suppliers)

- 1** *Reasons for the specification of production parts* **2**
- 2** *General description* **2**
- 3** *Material choice* **3**
- 4** *Tolerances/Dimensions* **4**
- 5** *CAM parts* **5**
- 6** *Requirements for large aluminium panels*..... **9**
- 7** *Engravings* **10**
- 8** *Engravings according to variants* **10**
- 9** *Requirements for sheet metal parts*..... **11**
- 10** *Requirements for test objects/measurement logs* **18**
- 11** *Requirements for welded parts* **19**
- 12** *Requirements for glass panes* **20**
- 13** *Requirements for damageable surfaces* **21**
- 14** *Requirements for cleanroom components*..... **21**
- 15** *Tidiness*..... **21**
- 16** *ESD*..... **21**
- 17** *surface coating* **23**
- 18** *Quality, packaging and delivery conditions* **25**
- 19** *Complaint* **25**
- 20** *Key to the symbols* **26**
- 21** *Document history* **30**

1 Reasons for the specification of production parts

Due to the increasing complexity of components, there are more and more additional fields and abbreviations on drawings that make the entire drawing more complex. In many cases, the same symbols always appear on the drawings with which the suppliers of Baumann GmbH are very familiar. However, there are also certain symbols or drawing comments that are very company-specific and can be ambiguous. In order to make the drawings clear, these additions are deliberately kept as short as possible. In case of ambiguities on the drawings, this "specification sheet" can be consulted in which certain drawing supplements are explained in more detail. This "specification sheet for production parts", which is **always** valid, is intended to provide information on the quality and accuracy of the parts to be produced. Should further queries nevertheless arise, please contact the "Drawing Hotline" at: 09621/67 54 214.

2 General description

Article number

At Baumann GmbH, the production parts have unique article numbers. If you have any questions about the drawing, component or product, please always have the article number ready.

Old article numbers (K-numbers) can be converted as follows:

Current article number:	K-00007645
Replace the characters "K-" with a "1":	100007645
A "-" is used as thousands separator:	100-007-645

Allgemeintoleranzen: General tolerances: ISO2768-mK		Ausnahme für Allgemeintoleranzen: Längenmaße: über / over 120 bis / up to 4000 ±0,3 exception for general tolerances: linear measures:												
Oskar-von-Miller-Str. 7 92224 Amberg Germany fon +49 (0) 9621 6754 0 fax +49 (0) 9621 6754 922														
Scale 1:5 EN AW-ALMg4,5Mn (Fortal5083-G5-S)		<table border="1" style="width: 100%; border-collapse: collapse;"> <thead> <tr> <th style="width: 10%;">Date</th> <th style="width: 10%;">Name</th> <th style="width: 80%;">Title</th> </tr> </thead> <tbody> <tr> <td style="font-size: small;">Drawn</td> <td>23.10.2013</td> <td rowspan="2" style="font-size: large; vertical-align: middle;">Tisch - Platte - -</td> </tr> <tr> <td style="font-size: small;">Checked</td> <td>14.01.2014</td> </tr> <tr> <td colspan="2" style="font-size: small;">Article number:</td> <td style="font-size: large; text-align: center;">100-102-081</td> </tr> </tbody> </table>		Date	Name	Title	Drawn	23.10.2013	Tisch - Platte - -	Checked	14.01.2014	Article number:		100-102-081
Date	Name	Title												
Drawn	23.10.2013	Tisch - Platte - -												
Checked	14.01.2014													
Article number:		100-102-081												
1 2x M4 hinzu Ø10 Durchbruch/Befestigung Sicherh		table - plate - - 1 / 1 A1												
State	changes	Date	Name											
Article number old: K-00102081		Project: PROF.FILE-ID: 10242209 B												

Amendment directory



If changes to components occur, these are documented and explained in the title block on the drawing. The changed elements, such as hole spacing, number of holes, threads, external dimensions, etc. are marked on the drawing with the symbol in the heading. If "revised" or "completely revised" is indicated, the changes were so extensive that an explanation of the individual changes would have become too confusing. If there is a dot (".") or a dash ("-") in the change history in the second column, or if there is no index in the first column, no change took place despite the change notice and no symbol appears in the drawing. A distinction is made between a revision index (A, B, C, ...) and a change index (1, 2, 3, ...; previously also: a, b, c, ...). With a new revision, the change index always starts again at zero (empty). So only revision index+change index in combination are unique (e.g. "C" is newer than "B2")!

New indices as of 11.10.2021:

The previous revision indices will be omitted in the future and the change index will be incremented continuously. Thus, the sole change index becomes unique. Old drawings that have not yet been updated will continue to have the revision and change index. As soon as the drawing is updated, the change index is incremented continuously and the old revision and change indexes are copied to the description field for better traceability.

old drawing

AUTOMATION baumann			
Oskar-von-Miller-Str. 7 92224 Amberg-Germany		fon +49 (0) 9621 6754 0 fax +49 (0) 9621 6754 922	
A 2	Länge 730 war 750	04.02.20	falkdo
A 1	Schrägen angepasst	17.01.20	falkdo
A	Bauteil überarbeitet	17.12.19	falkdo
1	Langloch hinzu	03.12.19	falkdo
State	Changes	Date	Name

new refreshed drawing

AUTOMATION baumann			
Oskar-von-Miller-Str. 7 92224 Amberg-Germany		fon +49 (0) 9621 6754 0 fax +49 (0) 9621 6754 922	
4	A2 Länge 730 war 750	04.02.20	falkdo
3	A1 Schrägen angepasst	17.01.20	falkdo
2	A Bauteil überarbeitet	17.12.19	falkdo
1	Langloch hinzu	03.12.19	falkdo
State	Changes	Date	Name

3 Material choice

Manufacturing parts for which a material certificate is required must also be manufactured from the material specified in the drawing. If "standard materials" are specified in the drawing, e.g.

- S235
- Al
- stainless steel

If there are no special requirements for the exact material, surface or heat treatment, the supplier can decide for himself the exact specification of the material within the material group.

For all other materials specified in the drawing, the components must be manufactured from the required or higher quality material. In case of doubt, a short consultation should be held (telephone: 09621/67 54 214).

No alternativ choice allowed for following materials:

- X6Cr17 (1.4016)

If the surface treatment is indicated in the material field, pre-treated semi-finished products may be used. In this case, the end faces + machined surfaces do not have to be post-treated. This applies to the following materials, for example:

- - S235JR, galvanized
- - EN AW-ALMgSi0.5 - anodized/anodized (anodizing color is always "natural")

The following materials are available for plastic protective screens:

- "PC"
- "PC, antistatic" Colour: colourless: = raw material "EUROPLEX-SDX-F"
- "PC, antistatic" Colour: tinted = raw material "ESLON® PC Sheet 427 smoke brown, antistatic".

The protective screens must be delivered with protective film, preferably 100µm, but at least 70µm.

If V2A is specified for sheet metal parts, cold-rolled sheet metal up to and including a thickness of 6 mm should be supplied, hot-rolled sheet metal above this.

4 Tolerances/Dimensions

The tolerances and dimensions indicated on the drawing must be observed. If machined dimensions are not tolerated, the general tolerance ISO 2768-mK indicated in the labelling field shall apply to these dimensions/surfaces. Except for length measurements over 120mm to 4000mm, here the tolerance of $\pm 0.3\text{mm}$ specified in the labelling field applies.

The principle of independence according to DIN ISO 8015 always applies, even if there are no corresponding notes on the drawing. Surfaces with fitting or tolerance dimensions must be flat and parallel to each other according to the tolerance size.

Marked unmachined external dimensions remain in the raw state. Here the tolerance of the respective standard of the starting material must be observed.

E.g. FI 60 * 10 * 200 DIN174 1.0037

Thickness h11 (h12); straightness (length) "directed towards the eye

If there is no explicit surface specification on the drawing at the end face of the component or if the general specification for aluminium components is "Ra6.3" or for steel components "Ra12.5", a saw cut at the ends of the semi-finished products is sufficient.

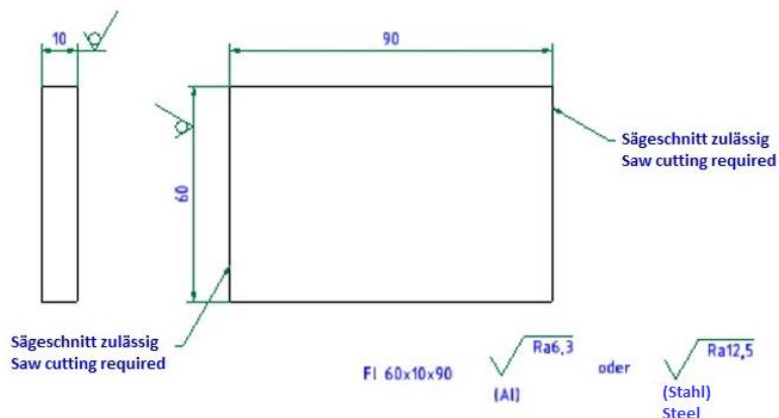

5 CAM parts

For complex parts, only the dimensions typically required in the manufacturing process are dimensioned. These parts are marked with following symbol on the drawing „CAM-Teil: unbemaßte Kontur aus .step Daten, Farbcodes VX.X beachten“ „CAM part: undimensioned contour from .step data, observe color codes“.

Toleranzangabe gilt:
Positionsgenauigkeit zueinander $\pm 0,02$

CAM-Teil: unbemaßte Konturen aus .step Datei, Farbcodes V2.1 beachten

tolerance indication applied:
positional tolerance to each other $\pm 0,02$

CAM part: undimensioned contour from .step data, observe color codes V2.1

Allgemeintoleranzen: General tolerances: ISO2768-mK	Ausnahme für Allgemeintoleranzen: Längenmaße: exception for general tolerances: linear measures: <table style="width: 100%; border: none;"> <tr> <td style="border: none;">über / over 120</td> <td style="border: none;">±0,3</td> </tr> <tr> <td style="border: none;">bis / up to 4000</td> <td style="border: none;"></td> </tr> </table>	über / over 120	±0,3	bis / up to 4000	
über / over 120	±0,3				
bis / up to 4000					

Scale: 2 : 1 EN AW-ALMg4,5Mn (Fortal5083-G5-S)	Title: Grundplatte EOL
Article number: 100-589-519	base plate EOL 1 / 1
Date: 20.09.2022 Checked: 06.02.2023	Name: strobeljo Title: A1

only elements that are not defined by contour or color of the 3D model are dimensioned:

dimensioned	undimensioned
outer dimensions	all contours which are under general tolerances
fit dimension	bore / thread / counterbore dimension
dimensions with smaller tolerances then general tolerance	Fit / bore / thread / counterbore position
dimensions with unsymmetrical tolerances	radii / chamfers
shape and position tolerances	
test dimensions	
outer threads + special threads	
Annotations (general, edge condition, text engraving, changes, etc.)	

For each part, the zero point of the part must be clearly defined. This should be done by means of the zero point of the coordinate dimensioning. If form and position tolerances are necessary, the zero point can also result from the reference A/B/C.

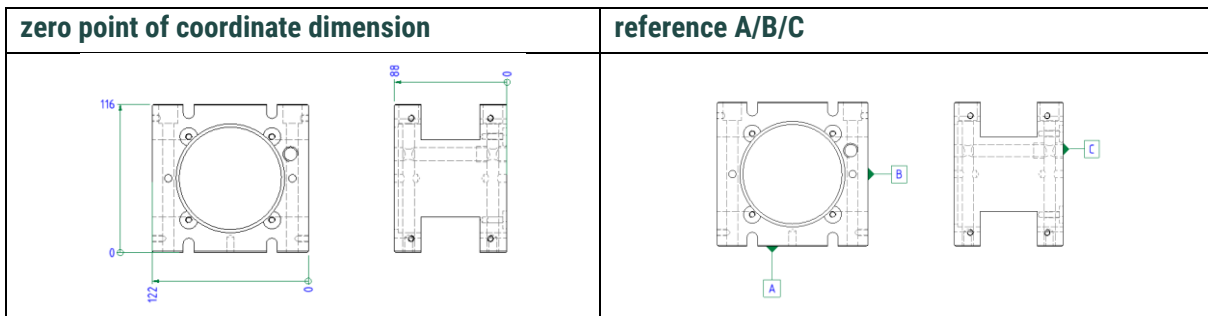

For undimensioned elements, the following always applies: The dimension from the zero point is assigned the corresponding tolerance (general tolerance or tolerance assigned via colour).

Example: for the edge marked in green, dimension 60 applies with the corresponding general tolerance.

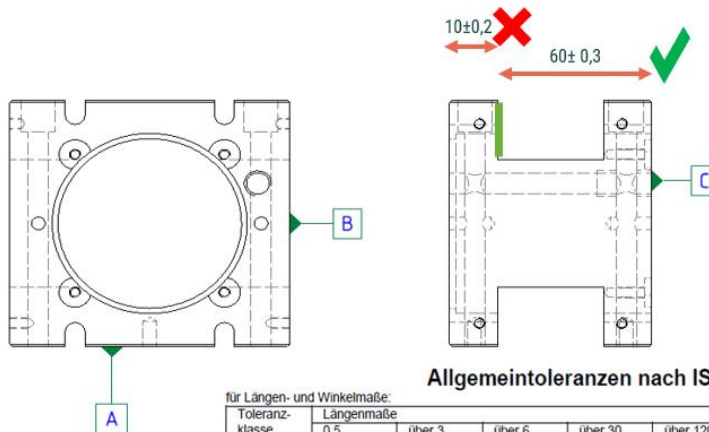

Allgemeintoleranzen nach ISO 2768:

für Längen- und Winkelmaße:		Längenmaße							
Toleranz- klasse	Längenmaße	0,5 bis 3	über 3 bis 6	über 6 bis 30	über 30 bis 120	über 120 bis 400	über 400 bis 1000	über 1000 bis 2000	über 2000 bis 4000
m (mittel)	±0,1	±0,1	±0,2	±0,3	±0,5	±0,7	±1,0	±1,2	±1,5

bei Baumann: ±0,3

If the 3D model and the drawing contain contradictory information, the information on the 2D drawing shall apply.

colour codes

colour defintion Baumann V2.1									
unused lines outdrawed									
Machining type	RGB - value			tolerances					
				drills			surfaces		
	R	G	B	diameter	position	roughness Ra	dimension	position	roughness Ra
unmachined surface	000	128	000				ISO 2768-mK		steel: 12,5 al: 6,3
roughing	none					steel: 12,5 al: 6,3	ISO 2768-mK		steel: 12,5 al: 6,3
finished	095	000	000	±0,5	±0,5	steel: 6,3 al: 3,2	±0,5	±0,5	steel: 6,3 al: 3,2
	252	228	214	±0,2	±0,2		±0,2	±0,2	
superfinishing	183	183	220	±0,1	±0,1		±0,1	±0,1	
	064	255	064	±0,05	±0,05	3,2	±0,05	±0,05	3,2
	128	128	000	±0,02	±0,02		±0,02	±0,02	
fitting hole E9/e9	50	200	100	E9/e9	±0,02	0,8	E9/e9	±0,02	0,8
fitting hole F7/f7	50	175	150	F7/f7	±0,02	0,8	F7/f7	±0,02	0,8
fitting hole H11/h11	50	150	200	H11/h11	±0,02	0,8	H11/h11	±0,02	0,8
fitting hole H6/h6	50	100	150	H6/h6	±0,02	0,8	H6/h6	±0,02	0,8
fitting hole H7/h7	0	0	255	H7/h7	±0,02	0,8	H7/h7	±0,02	0,8
fitting hole H9/h9	100	50	200	H9/h9	±0,02	0,8	H9/h9	±0,02	0,8
fitting hole J7/j7	150	50	150	J7/j7	±0,02	0,8	J7/j7	±0,02	0,8
fitting hole K6/k6	200	50	100	K6/k6	±0,02	0,8	K6/k6	±0,02	0,8
special fitting hole	205	095	050		±0,02	0,8			
thread (Core diameter according to DIN/ISO) Thread run-out according to Baumann standard	255	255	000	DIN 13 T1	±0,1				
thread short (Core diameter according to DIN/ISO) Thread run-out according to Baumann standard - short	255	175	175	DIN 13 T1	±0,1				
fine thread (Core diameter according to DIN/ISO) Thread run-out according to Baumann standard	255	175	000	DIN 13 T2-T10	±0,1				
fine thread short (Core diameter according to DIN/ISO) Thread run-out according to Baumann standard - short	255	095	000	DIN 13 T2-T10	±0,1				
inch thread	211	045	96						
simple hole	none			ISO 2768-mK					

internal threads

For internal threads, the size + pitch results from the colour coding + the core diameter. The thread run-out for blind tapped holes also results from the colour coding. If the thread run-out does not correspond to the standard, the thread size + length must be dimensioned on the drawing derivation.

The following thread run-outs apply according to the Baumann standard

pitch P	thread d	standard case e	short case baumann
0,25	M1	1,5	0,6
0,35	M1,6	2,1	0,8
0,4	M2	2,3	0,9
0,45	M2,5	2,6	1
0,5	M3	2,8	1
0,7	M4	3,8	1,4
0,8	M5	4,2	1,6
1	M6	5,1	1,9
1,25	M8	6,2	2,3
1,5	M10	7,3	2,7
1,75	M12	8,3	3,1
2	M16	9,3	3,4
2,5	M20	11,2	4,1
	G1/8	5,1	1,9
	G1/4	7,3	2,7
	G3/8	7,3	2,7
	G1/2	9,3	3,4

6 Requirements for large aluminium panels

Unless otherwise indicated on the drawings, the following tolerances apply **after** finishing to all Fortal5083-G5-S plates or better:

G5-S (fine milled)	
surface roughness	Ra 3.2
parallelism	$< \frac{0,1}{3000}$ ($\cong 0,1\text{mm je } 3 \text{ meter length}$)
evenness	$< 0,2 \text{ mm je meter length}$
component thickness tolerance	$\pm 0,1$
Length and width tolerance	+ 0,0 - 0,5

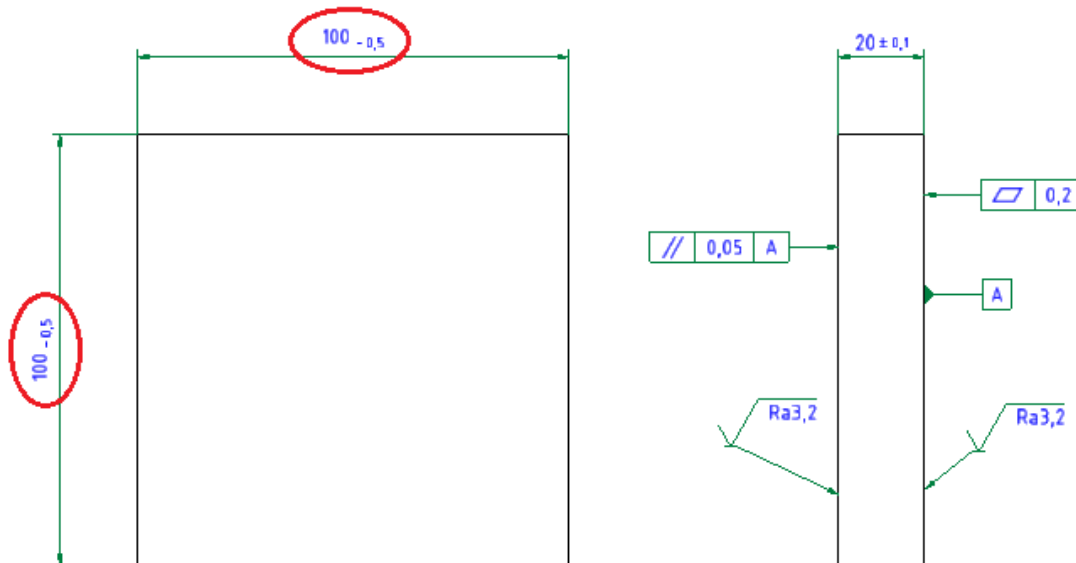

7 Engravings

If possible, all engravings or labels will be made with the font "Arial" and, if not otherwise specified, with a font height of 3 mm. A smaller font height can of course be used for small components or small marking areas.

When engraving/labelling, care must be taken to ensure that these do not penetrate into holes (etc.) or protrude beyond the component itself. In addition, the position of the title block indicated on the drawing must be observed. Unless otherwise stated, engravings may be milled or produced by laser. The prerequisite, however, is that the engravings are clearly legible (even after a possible surface coating)! For this purpose, the engravings must be made with a marking laser.

If "laser-signed" is indicated on the drawing, the contours can be marked with the cutting laser (this is usually sufficient for position markings or article numbers).

The article number shown on the component views must always be engraved (this may differ from the article number in the title block).



8 Engravings according to variants

Placeholders for engravings must be filled with the variant text from the order. The placeholder is marked on the drawing and there is an example of how it should look.

Red: The string that is to be replaced by the variant from the order.

Green: examples of how it should look in the end

Orange: Content of the DMC

Examples of normal engraving and DMC:

- Consecutive numbering with leading zeros

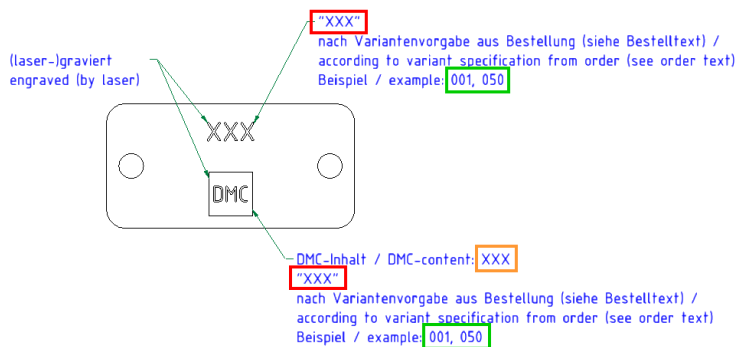

- Consecutive numbering with leading zeros and fixed text

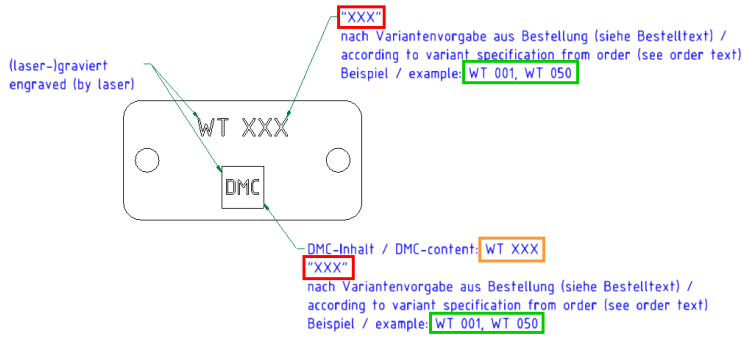

- Consecutive numbering without leading zeros with fixed text

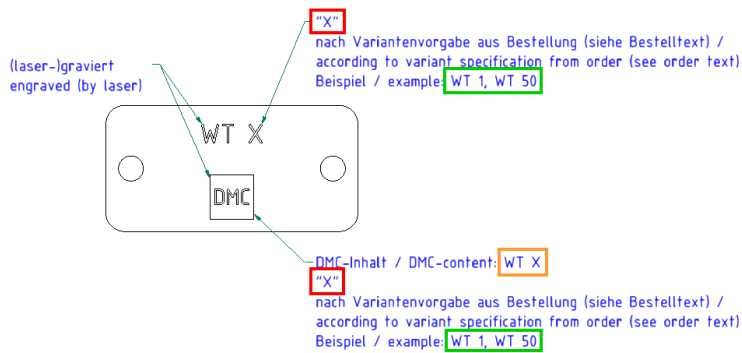

In the purchase order, the variant is specified in the purchase order item. A hyphen between two numbers indicates the span for consecutive numbering.

All prices are in EUR exclusive of VAT.

Item	Quantity	Article description	Total Price
1	6.00 piece	Article No. 510001-510006 Graverschild Variants: 510001-510006 Nach beiliegender Zeichnung fertigen! Net unit price [1.00 Stück]	0.00 0.00

Example for the picture: 6 pieces with the engravings 510001, 510002, 510003, 510004, 510005 and 510006 are to be produced.

9 Requirements for sheet metal parts

- **Dimensions of sheet metal parts**

For sheet metal parts (as well as for surface elements such as PC or Makrolon sheets or surface seals), only the dimensions typically required in the manufacturing process are dimensioned. The following applies to all undimensioned elements: The dimensions can be taken from the .step model!

The following rules apply to dimensioning:

dimensioned	undimensioned
--------------------	----------------------

Bending dimensions	Dimensions that have nothing to do with bending
Bending angle (if $\neq 90^\circ$)	Bending radius
Sheet thickness	Bending angle 90°
Threads (only dimension)	Hole position and dimension
Countersinks (only dimension)	radius/chamfers
Dimensions of the unfolded view (as reference)	
annotations (general, edge transitions, text engraving, changes, etc.)	
Tolerances that are more accurate than general tolerances	

for all undimensioned elements the general tolerances according to DIN EN ISO 9013 Tolerance class 1 apply, for sheet thickness >1 to $\leq 3,15$ thus applies:

nominal dimension	$>0 <3$	$\geq 3 < 35$	$\geq 35 < 315$	$\geq 315 < 4000$
limiting dimension	$\pm 0,1$	$\pm 0,2$	$\pm 0,3$	$\pm 0,4$

For all linear dimensions produced by forming (bending) the tolerances according to DIN 6930 part 2 m apply:

Nominal dimension	1 to 6	over 6 to 10	over 10 to 25	over 25 to 63	over 63 to 160	over 160 to 400	over 400 to 1000	over 1000 to 2500
limiting dimension for sheet thickness over 1 to 3	$\pm 0,2$	$\pm 0,3$	$\pm 0,4$	$\pm 0,6$	$\pm 0,8$	$\pm 1,2$	$\pm 1,6$	$\pm 2,4$
limiting dimension for sheet thickness over 3 to 6	$\pm 0,4$	$\pm 0,5$	$\pm 0,6$	$\pm 0,8$	$\pm 1,0$	$\pm 1,2$	± 2	± 3

The tolerances according to DIN EN ISO 13920 B apply to all length dimensions produced by welding:

nominal dimension	0 to 30	over 30 to 120	over 120 to 400	over 400 to 1000	over 1000 to 2000	over 2000 to 4000
limiting dimension	$\pm 1,0$	$\pm 2,0$	$\pm 2,0$	$\pm 3,0$	$\pm 4,0$	$\pm 6,0$

- Deburring of components**

With sheet metal parts, it must be ensured that all cut edges are cleanly deburred. Sharp-edged "noses" are not permitted and must also be removed.

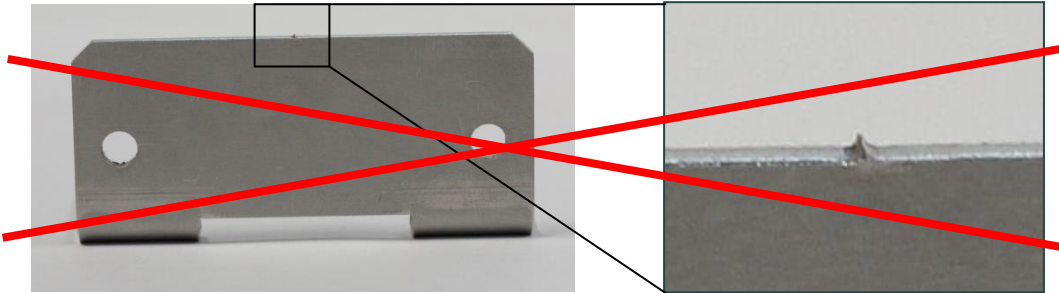

- Impressions during bending**

If there is no comment on the drawing, impressions resulting from bending are permissible.



Impression caused by the bending.

- surfaces/scratches**

Sheet metal parts should have surfaces that are as clean as possible, and care should be taken when handling them to avoid visible scratches!

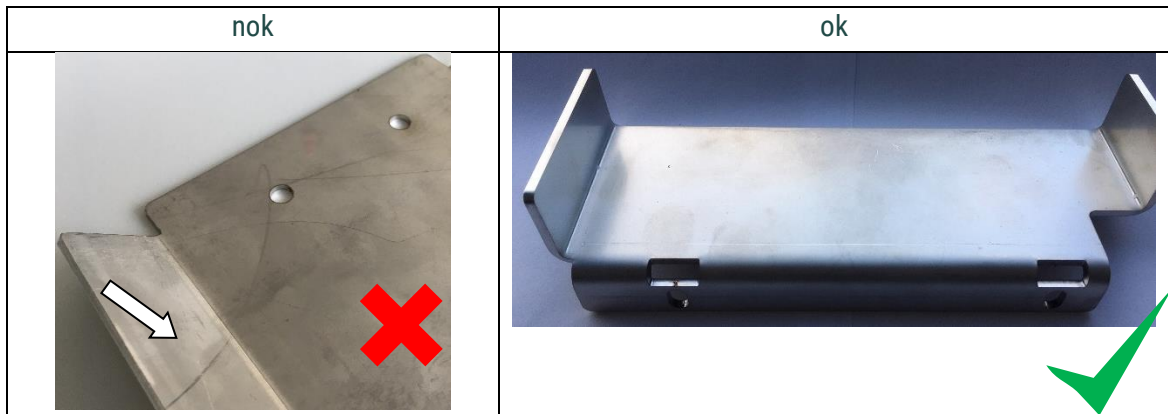

- Labeling**

Any labels on the semi-finished product must be removed!

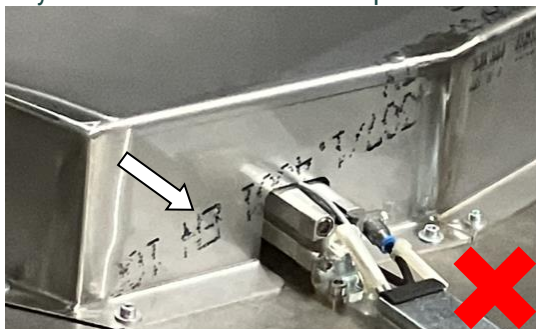



- **perforation**

The outer dimensions of perforated components are specified and relevant. The width of the perforation groove can be selected at will and should be between 1mm and 2mm if possible. The number of webs and positions must be selected in such a way that the part to be broken out is sufficiently firmly connected to the rest on the one hand and can be broken out with only a few cuts on the other.

- **Design with information "Spot welded" or "Tightly welded".**

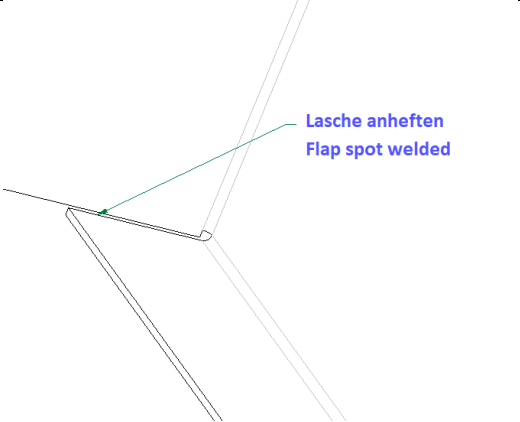
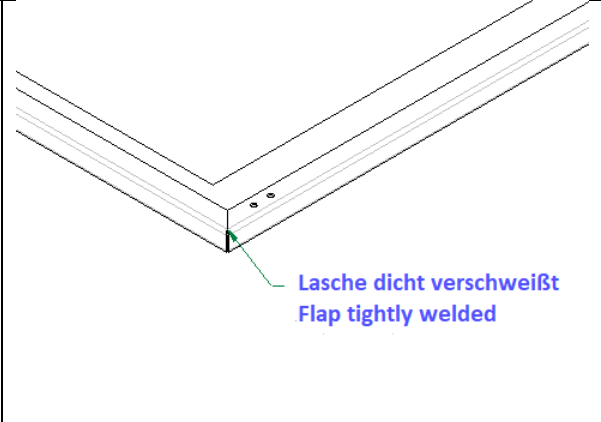
If the respective passage is indicated on a drawing, this is to be carried out as follows:

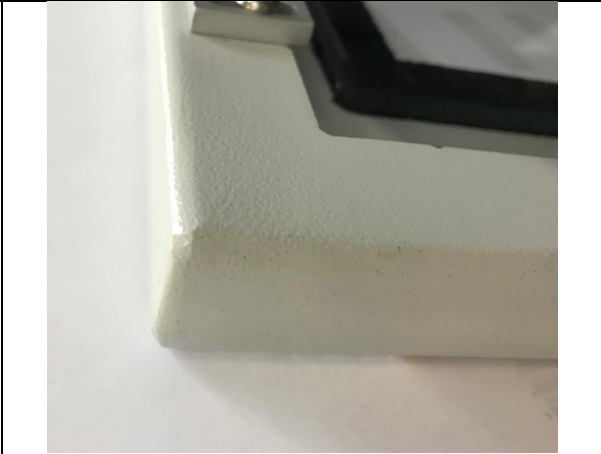
Leakproof welded	Tightly welded
	
	
<p>The flaps should only be welded together at certain points (mainly for reasons of rigidity).</p>	<p>tight welding + rounding (optics after powder coating see bending edge)</p>

- **Grinding of welded edges**

If no "visible edge" is indicated on the drawings or if there is an indication that the welded edges are to be ground, they may remain unmachined.



- Powder coating of folded components**

Edged components that are powder-coated must be stapled from edge to edge to avoid coating cracks later on. If it is not clearly stated where stapling is permitted or where stapling is not permitted, telephone consultation should be held. (Phone: 09621/67 54 214)

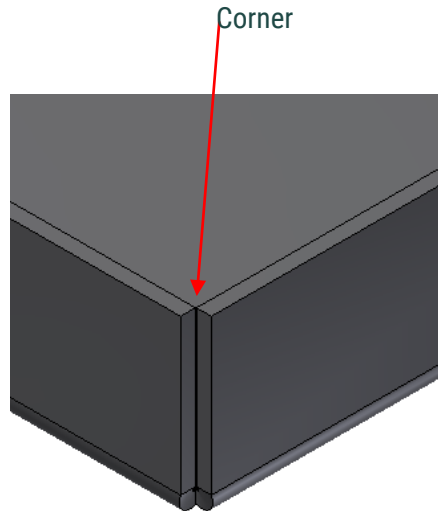

Set the tacking points as shown on the drawing!
(inside or outside)

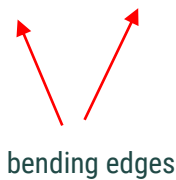

- Welding of hinge part Dirak 243-9001 (article number 100-071-232)**

Baumann mainly uses this hinge for the storage of cladding doors. It may be used by the supplier as a welded version and as a version fixed with welding studs. The following must be observed for the welded version:

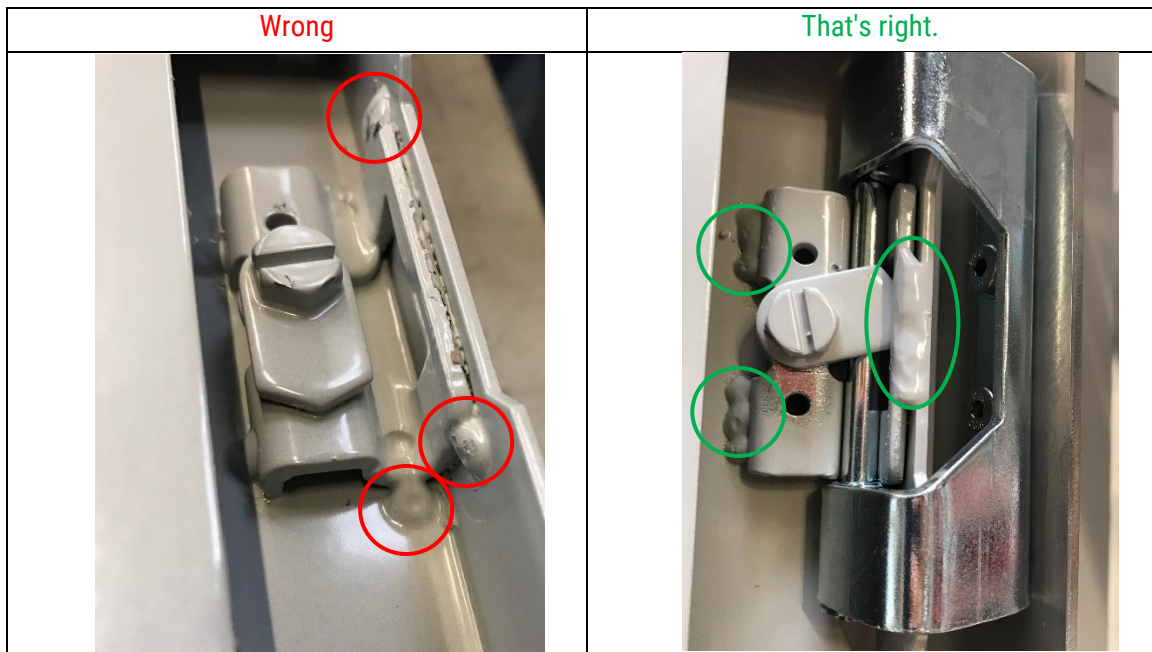

- **Inserting rivet nuts**

Rivet nuts are generally only riveted by Baumann itself. If there is a note on the drawing regarding a rivet nut, only the corresponding bore should be made for it. If the required diameter is not apparent from the drawing, please contact us by telephone. (Phone: 09621/67 54 214)

- **Galvanized sheets**

If galvanized is indicated in the marking field for the material (e.g. S235JR, galvanized), an already galvanized sheet may be used as semi-finished product. It doesn't need to be galvanized again afterwards.

If galvanized is indicated as the surface specification above the marking field, the finished component must be galvanized.

10 Requirements for test objects/measurement logs

If creation of a measurement report is required, the following requirements apply:

- Measurement report creation is only necessary for marked dimensions and marked form and position tolerances
- Number must be applied permanently and not in a raised position (e.g. laser engraved)
- Entry only permitted in the marked area
- For each serial number a protocol in pdf-format has to be created
 - Name: MP_Art.No_SerialNumber.pdf
 - Example: MP_100-448-600_SN-027303
- Engraving, which is on the part, is also to be mentioned in the protocol
- The serial numbers to be used for the engraving are communicated via the order item (if these are missing, they must be requested from BAUMANN).
- The serial number is a consecutive number generated by the Baumann systems.
- please send measurement logs (in pdf) to messprotokolle@baumann-automation.com

Pos.	Menge	Artikelbezeichnung	Gesamtpreis
1	2,00 Stück	Artikel-Nr. 100-026-370 Rev.: C Index: 2 Führung - Hülse - Abstreifen - FET Nach beiliegender Zeichnung fertigen! Folgende Messprotokoll-/Serien-Nr. sind zu verwenden: SN-050622 SN-050623 Nettoeinzelpreis 0,00	0,00
Liefertermin eingehend: 02.03.2022			

Maße zu testen
 Dimensions to be tested

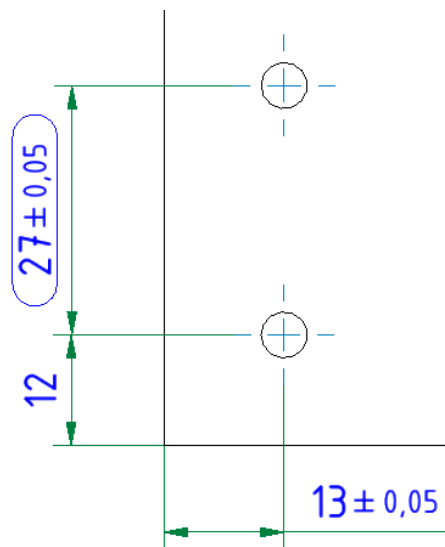

11 Requirements for welded parts

In the case of welded parts, no or not all permissible weld seams are usually drawn in under normal requirements. A professional welding adapted to the dimension of the parts is assumed.

Please note that areas where welding is not permitted are clearly marked on the drawing with a note:

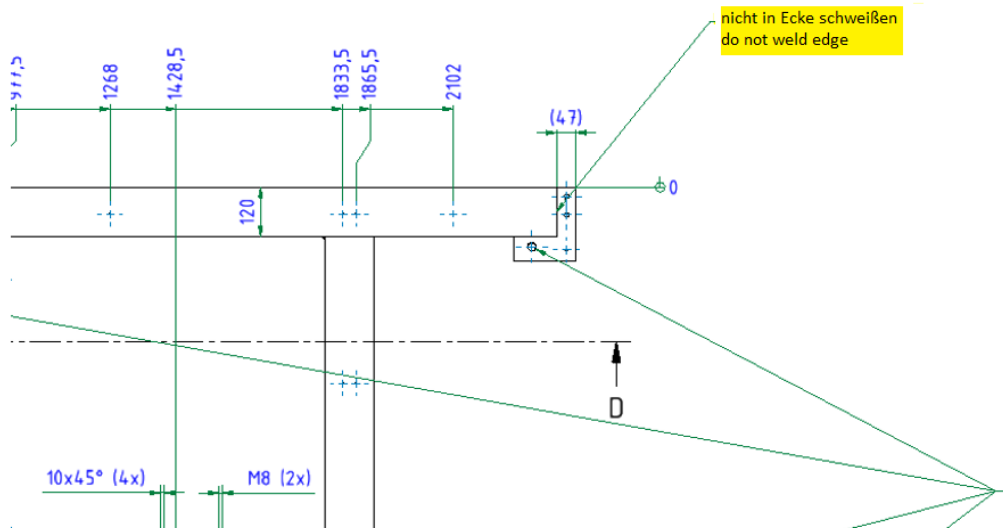

All non-tolerated dimensions and unmachined surfaces of welded parts shall be manufactured in accordance with the general tolerance DIN EN ISO 13920 B.

As far as available, only hot-rolled material should be used for welding. Thermally cut surfaces must be reworked (due to oxide residues).

In principle, welding must not be carried out in cold-formed areas. In principle, the seam thickness should be kept as small as possible.

Furthermore, no slag residues and welding beads must remain on the component. Any protruding weld seams on the outer sides must be sanded. Professional or "clean" welding seams do not have to be plastered.

- **Preparation and post-processing of welded parts for powder coating/painting**

All components must be cleared of residues (chips, cutting oils, etc.) by the paver prior to coating. Particular attention must be paid to elements such as blind bores and threads.

It must also be ensured that threads are not soiled by powder residues after coating. This can be achieved either by clean covering beforehand or by re-cutting the threads. (see also chapter 15 surface coating)

12 Requirements for glass panes

In the case of glass components, the comments (e.g. anti-reflective on one side, anti-reflective on both sides, etc.) on the drawings must be taken into account and manufactured as specified.

If a drawing specifies "ESG Glas" as the material + color = getönt then the tint must be "gray".

If various stamps have to be provided (e.g. safety glass), these should be attached to the edge if possible. For glass components, the general tolerances according to DIN ISO 2768-mk are invalid. In this case, the following tolerances are permitted:

Permissible tolerances for glass panes - other	
evenness	approx. 1.5 mm per meter length
parallelism	1,5mm per meter length
Dimensional tolerances in mm	+ 0 - 2
Tolerance of chamfers in mm	1 x 45 ± 0,5
Bore distance tolerance between bores in mm	± 0,5
Bore distance tolerance from first bore to outer edge in mm	± 1
bore diameter	+ 0 - 0,5

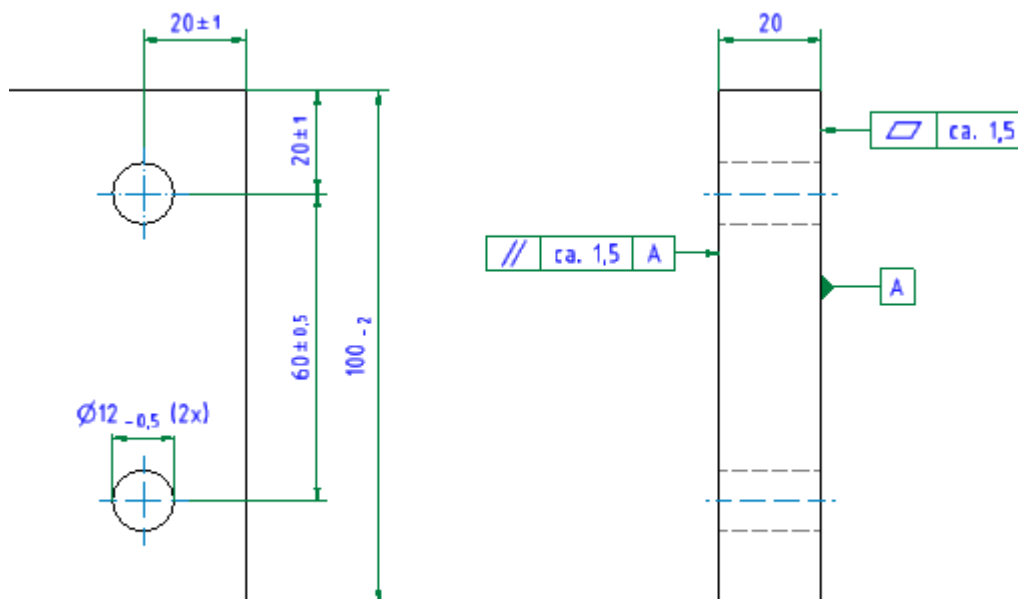

13 Requirements for damageable surfaces

An oxide layer is not permitted on copper parts that are to be used as electrical conductors.

Packaging instruction

After the manufacturing process, the component must be cleaned and freed from oxides. If the component comes into contact with a liquid during this process, a drying time must be allowed for before packaging.

After cleaning, the component must not be touched with bare hands. Gloves must be worn. The gloves must have the following characteristics:

Clean, grease-free, silicone-free, latex-free, DMF-free.

Components shall always be individually wrapped in paper. The packaging is to be sealed with the mandatory sticker "Use gloves". Alternatively, a sticker with the text: "! CAUTION - use gloves!" can be used. Filigree components are to be additionally packed in cushion foil.



14 Requirements for cleanroom components

Article must be washed in a qualified cleaning process after production and then packaged in the cleanroom. The article must be double-packed in a standard PE bag that is qualified for the cleanroom. A "ACHTUNG! Reinraum-Verpackung, nicht Öffnen! CAUTION! Cleanroom packaging, do not open!" sticker must be affixed to the packaging.

15 Tidiness

All production parts must be delivered in a clean, visually appealing condition. A visual inspection for uniform surface quality, stains, scratches and scale residues (etc.) must be carried out by the supplier.

16 ESD

- **Definition of ESD (Source: www.wikipedia.de)**

Electrostatic discharge (ESD) is a spark or breakdown caused by a large potential difference that causes a short, high electrical voltage pulse on an electrical device. Under unfavourable circumstances, this voltage pulse in the device can damage electrical components. This particularly affects field effect transistors. Another undesirable consequence may be the uncontrolled ignition of combustible gas. The cause of the potential difference is usually charging due to frictional electricity.

- **ESD capability**

Specification for production parts

If an ESD capability is required, the assembly/component must have a leakage resistance of $\leq 1\text{G}\Omega$ at every point. The surface resistance of the entire assembly/component must not exceed the limit resistance of $R_{0_grenz} \leq 1\text{G}\Omega$.

17 surface coating

For components to be painted or powdercoated, care must be taken to ensure an optically clean surface and professional workmanship. The surface must be treated according to the paint manufacturer's specifications.

If nothing to the contrary is indicated on the drawing, machined surfaces should only be painted, not primed, for reasons of accuracy.

For powdercoated parts, if nothing contrary is indicated, machined surfaces should be also powdercoated completely.

The surface coating must be clean, uniform and free of stains. Blue chromated parts must not have a yellowish tinge. Prior to coating, blind holes must be blown out to prevent corrosive salts from leaking later.

The drawings always indicate the fit required at the end of the manufacturing and surface treatment process.

If a surface treatment produces an application layer that changes the fit, this must be taken into account during production. An indication or adjustment in this respect in the drawing is not made!

The indicated dimensions and tolerances ALWAYS refer to the finished coated component.

Example:

For blue chromated parts, the layer thickness of 8-12µm (Ø 10µm) must be taken into account during production. For example, when manufacturing a slot with tolerance **4H7** (EI = 0; ES = +12), the tolerance field must be shifted by **2 x 0.01mm** during manufacturing. Thus the permissible tolerance for manufacturing is: **4.020 to 4.032**.

After the surface coating, the measurement is in the range of 3.996 to 4.016.

Exceeding the tolerance in the upper range is compensated by the stronger edge structure and is accepted. Bores such as Ø6H7 are to be produced with a standard plus reamer Ø6,02.

For blind bores, it is accepted that these are only coated at the top edge and are therefore too large at the bottom. For external dimensions, the above applies analogously to minus.

Plasma nitrided parts are always additionally oxidized with plasma. Oxidation gives the parts corrosion protection. Plasma oxidation corrosion protection must be all-round/full-surface. The following layer thicknesses apply:

standard layer thickness for plasma nitrided	
material	layer thickness
1.2312	0,2 – 0,3 mm
1.2842	0,2 – 0,3 mm
1.2379	0,08 – 0,1 mm
1.4034	0,03 – 0,05 mm
1.4112	0,03 – 0,05 mm

For chemically nickel-plated components, the layer thickness of 8-11 µm must also be taken into account. Due to the more precise coating, tolerances of 0.02 can be maintained.

If a stainless steel is vacuum-hardened, it must remain corrosion-resistant even after tempering.

Components with the drawing specification "blue chromated" can also be chemically nickel plated.

However, this does **not** apply in the opposite sense!

Unless otherwise stated on the drawing, the following layer thicknesses must be adhered to as standard:

Standard coating thicknesses for surface coatings	
surface treatment	coating thickness
anodize	~ 10µm
Hard coat	~ 25µm
Blue chromate	~ 5 - 10µm
Black chromate	~ 5 - 10µm
Chemical nickel plating	8 ⁺ µm
black passivated	8 µm

Aluminum parts

The surface treatment indicated on the drawing must be carried out.

Hard coating

The electrical contact point of the parts during hard coating must under no circumstances lie on mating surfaces. Threads are preferred. If no threads are available, a thread must be inserted after consultation with the drawing info!

18 Quality, packaging and delivery conditions

The quality of external supplies directly contributes to the quality of our products. We therefore expect high quality from our suppliers for all delivered materials and production parts. We strive for a close and trusting cooperation with our suppliers with the aim of continuously improving quality and achieving zero-defect quality as well as 100% adherence to delivery dates.

Please see Document “Anliefer- und Dokumentenbedingungen” for detailed instructions

Changes

In any case it requires our written approval that changes may be carried out. Drawings must be used in the respective valid version.

19 Complaint

Should we receive a complaint from the supplier in spite of an outgoing goods inspection, the supplier will be contacted immediately, if necessary with pictures and measurement reports. The rework or new production must be carried out in the quickest way under the responsibility of the supplier.

The shipping costs from our company to the supplier and back will be borne by the supplier.

In exceptional cases and after consultation, as well as previous cost clarification, the rework can also be carried out in our house.

The procedure in the event of a complaint must be coordinated individually in each case.

20 Key to the symbols

- **tight welding of pipes - weld pipes closed**

Under "Pipe tight welding" a tightness for liquids is required. A standard test certificate for the tightness of the pipes is not required. The tightness of the entire system is only checked in suspicious cases. The exact conduct of the audit must be determined and agreed in each individual case.

- **flap tightly welded - flap leakproof welded**

A tightness for liquids is required under "Flap tightly welded". A standard test certificate for the tightness of the lugs is not required unless explicitly required. The tightness of the entire system is only checked in suspicious cases. The exact conduct of the audit must be determined and agreed in each individual case.

- **Parts must be welded together light-proof - Parts together light-proof welded**

A standard test certificate for the light-tightness of the assemblies is not required unless explicitly required. Only in the event of problems is an inspection to be carried out after prior consultation and, if necessary, reworking carried out.

- **Edge states**

Symbol of edge states relates to DIN ISO 13715.

Unless otherwise stated, the parts may also not be supplied burr-free and with sharp edges. If the drawing does not contain any other information on the machining of workpiece edges, all edges must be deburred as follows:

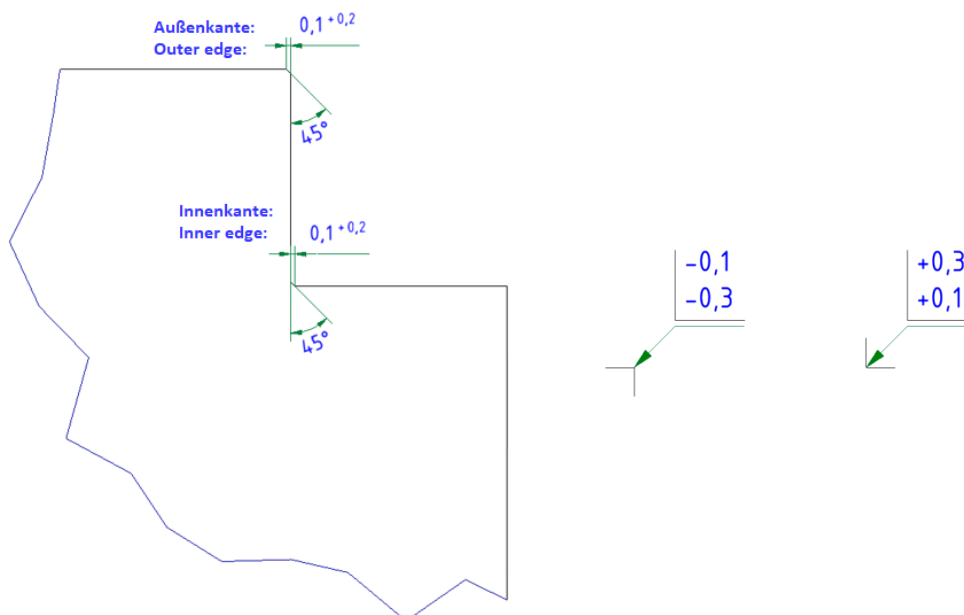

- surface finish**

If there is no information on the surface tolerances on the drawing, all surfaces to be machined must be produced with the surface quality Ra 12.5 or better. If no surface specification for unmachined surfaces is given on the drawing, these surfaces may remain in the raw state. If the surface Ra 6.3 is specified for aluminium parts, the saw edges do not need to be milled over.

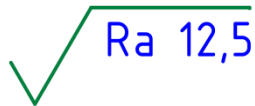

Surface symbol
Machined surface

- stainless steel ground**

If there is a reference to ground surfaces on the drawing, the specified brushing direction and grain size must be observed.

Description of the brushing directions:

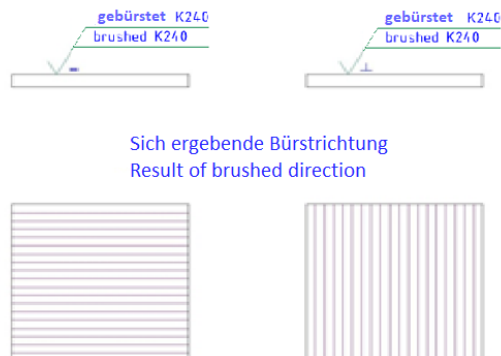

- fitting bores

für alle Passbohrungen einer Bearbeitungsebene ohne Toleranzangabe gilt:

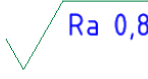
Positionsgenauigkeit zueinander $\pm 0,02$  Ra 0,8

for each fitting bore in one machining plane without tolerance indication applied:

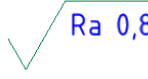
positional tolerance to each other $\pm 0,02$  Ra 0,8

The following tolerances or surface roughnesses apply to all fitting bores in a working plane that **do not have a** separate tolerance or surface specification in the drawing:

Position accuracy of the fitting bores in relation to each other	$\pm 0,02$
surface roughnesses	Ra 0.8
Angularity to flat surface	$\pm 0,05^\circ$

In most cases, the tolerance of the bores to each other is defined, not the dimension towards an outer edge (see drawing example below). Here the general tolerance indicated on the drawing continues to apply.

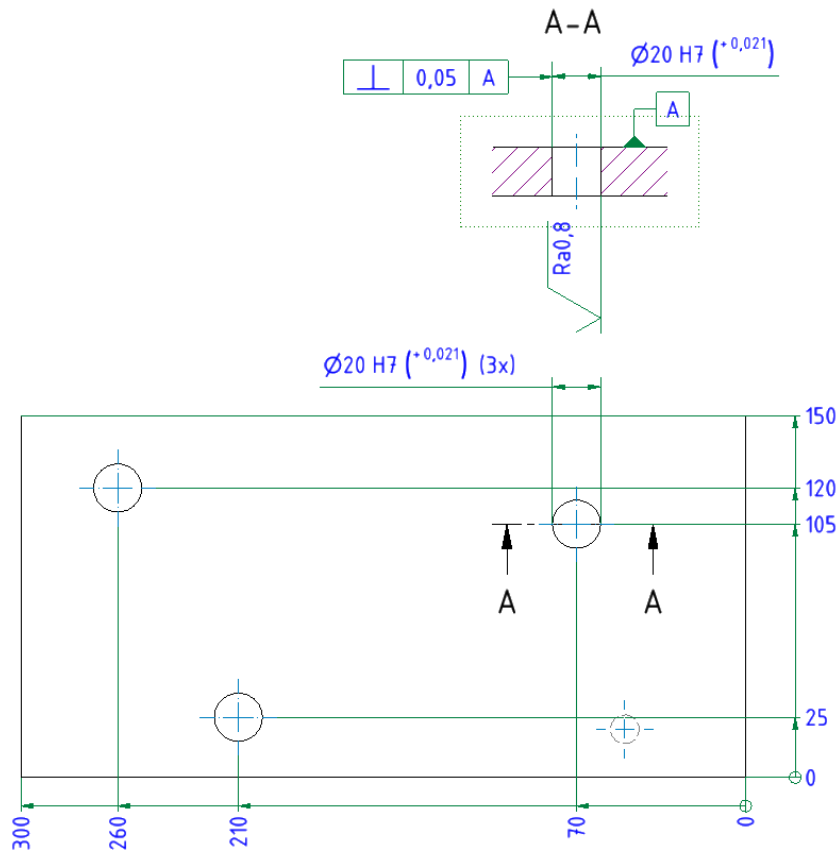

Description of the above drawing example:

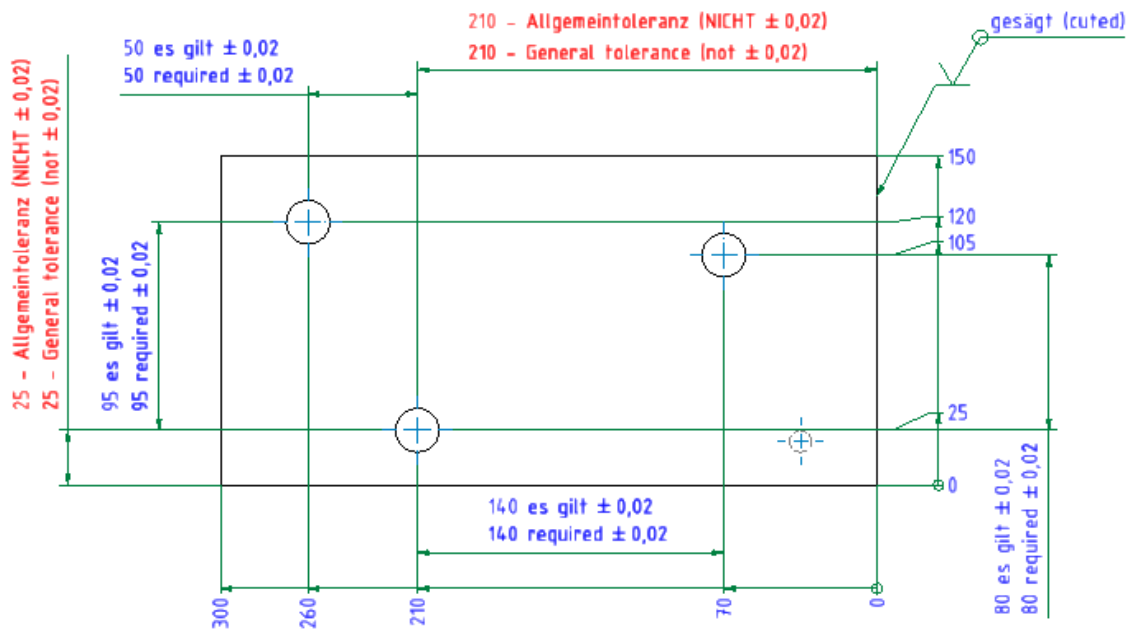

The following special cases are possible:

- If a tolerance from the bore to the outer edge is required, this dimension is tolerated separately.
- If the distances between bores of different machining planes must be provided with a tolerance, this distance is dimensioned and tolerated.
- If the position accuracies of the drill bores have to be measured, the dimension is specified as a function-related test dimension (see point 10).

21 Document history

on Request